

TECHNICAL DATASHEET



EF ELBOW 90°

04 Update - 12/2024

TECHNICAL DATA

Article No	001 117 2021 0180
d (mm)	180
D (mm)	217
Z (mm)	319
le (mm)	92
m (mm)	50,5
Weight (Kg)	4,680
Box Quantity (pcs)	2
Box Dimension (cm)	55x30x43,5

INJECTION MOULDED

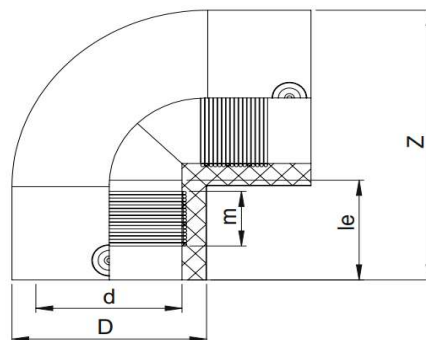

IDENTIFICATION OF PRODUCT

D(mm)	180
SDR	11
RAW MATERIAL	PE 100
PRESSURE CLASS	16 Bar Water 10 Bar Gas
TRADEMARK	NTG
EXECUTION	Injection Moulded
STANDARD	EN 12201-3 EN 1555-3 AS / NZS 4129
SPECIFICATION	Suitable for SDR11...17 pipe 4 mm pin connectors

EF SPECIFICATION

WELDING VOLTAGE	40 V
RESISTANCE	0,90 Ω
WELDING TIME	530 Sec.
COOLING TIME	20 Min.
WINDING TYPE	Monofilar
WELDING BARCODE	

981420331803400906530117

Tolerance on diameters and thickness according to the standards. The other dimensions are specialized. Tolerance $\pm 5\%$. NTG PLASTIK reserves all the right to change any information without giving prior notice. The production, distribution and utilization of this document without explicit authorization is prohibited.